

Walking in the Sandals of the Apostle Paul

“A Study in the Book of Acts”

Temple Baptist Church
July 30, 2023

Chronological Chart of Acts

Events	Acts	Dates
Ascension	1:9-11	A.D. 30
Pentecost	2:1-41	A.D. 30
Early church	2:42-6:7	A.D. 30
First persecution	4:1-31	A.D. 31
Second persecution	5:17-42	A.D. 32
Third persecution; Stephen's martyrdom	6:8-8:4	A.D. 35-37
Philip's ministry in Samaria and to the Ethiopian	8:5-40	A.D. 37
Paul's conversion	9:1-21	A.D. 38
Paul in Damascus, Asia, Jerusalem, Tarsus	9:22-30	A.D. 38-41
Peter at Caesarea	10:1-11:18	A.D. 41
Founding of Gentile church at Antioch	11:19-24	A.D. 41
Paul in Antioch	11:25-26	A.D. 43
Martyrdom of James; Peter imprisoned	12:1-19	A.D. 44
First missionary journey	13:1-14:28	A.D. 45-47
Jerusalem council	15:1-29	A.D. 50
Second missionary journey	15:36-18:22	A.D. 51-54
Third missionary journey	18:23-21:19	A.D. 54-58
Paul arrested in Jerusalem	21:20-23:22	A.D. 58
Paul a prisoner at Caesarea	23:23-26:32	A.D. 58-60
Paul's journey and arrival in Rome	27:1-28:31	A.D. 60-61

Roman Emperor-Nero 54 AD to 68 AD



Claudius & Nero



Agrippina & Nero

Defacto Roman Emperor- Agrippina 15 AD to 59 AD



Claudius & Agrippina

From 47 to 59 AD, she
Murdered no fewer than
12 individuals to assure
Nero would become
Emperor





PAUL'S THIRD MISSIONARY JOURNEY



ABC = Traditional region of Anatolia
ABC = Region of Greek settlement



BLACK SEA

Thrace

Paphlagonia

Pontus

Bithynia

Galatia

Troad

Mysia

Phrygia

Cappadocia

Lesbos

Lydia

Lycaonia

Chios

Aeolis

Ionia

Caria

Pisidia

Samos

Naxos

Doris

Lycia

Pamphylia

Cilicia

Rhodes

Crete

Cyprus

MEDITERRANEAN SEA



Alexandria



Lake Mareotis

Linked by canals to the Nile and Mediterranean, this lake—vital to shipping in Cleopatra's day, when Egypt supplied much of Rome's grain—is now much smaller.

Cleopatra's Alexandria

Founded by Alexander the Great in 331 B.C., this Mediterranean city became the world's most magnificent center of trade, culture, and learning under the Ptolemies. Ruins of the ancient buildings now lie under the sea and beneath modern construction. This re-creation shows what the city may have looked like during Cleopatra's reign, when a multicultural mix of perhaps 325,000 people made it their home.

Lake Mareotis

Canal of Alexandria

+ Royal quarter

+ Pharos lighthouse

Eastern Harbor

+ City details

Pharos Island

Western Harbor

+ Shifting shore

North

Alexandria



Mediterranean Sea

Ancient Alexandria, Egypt, Around the Time of Hypatia



PHAROS
Lighthouse

GREAT HARBOR
Cleopatra's Needles
in front of Caesarium

LIBRARY & MUSEUM

Amphitheatre

Eleusinian Underground Complex

$\phi = +31^{\circ}12' N$
 $\lambda = +29^{\circ}15' E$



0 Miles 1

palacios

Pharos Light House

Constructed from 284 to 246 BC

~338 feet high

Range 29 miles

Deactivated by earthquake in
1303 AD



Pharos Light House



Great Pyramid of Giza

481 feet high

Eifel Tower

984 feet high

Great Library of Alexandria

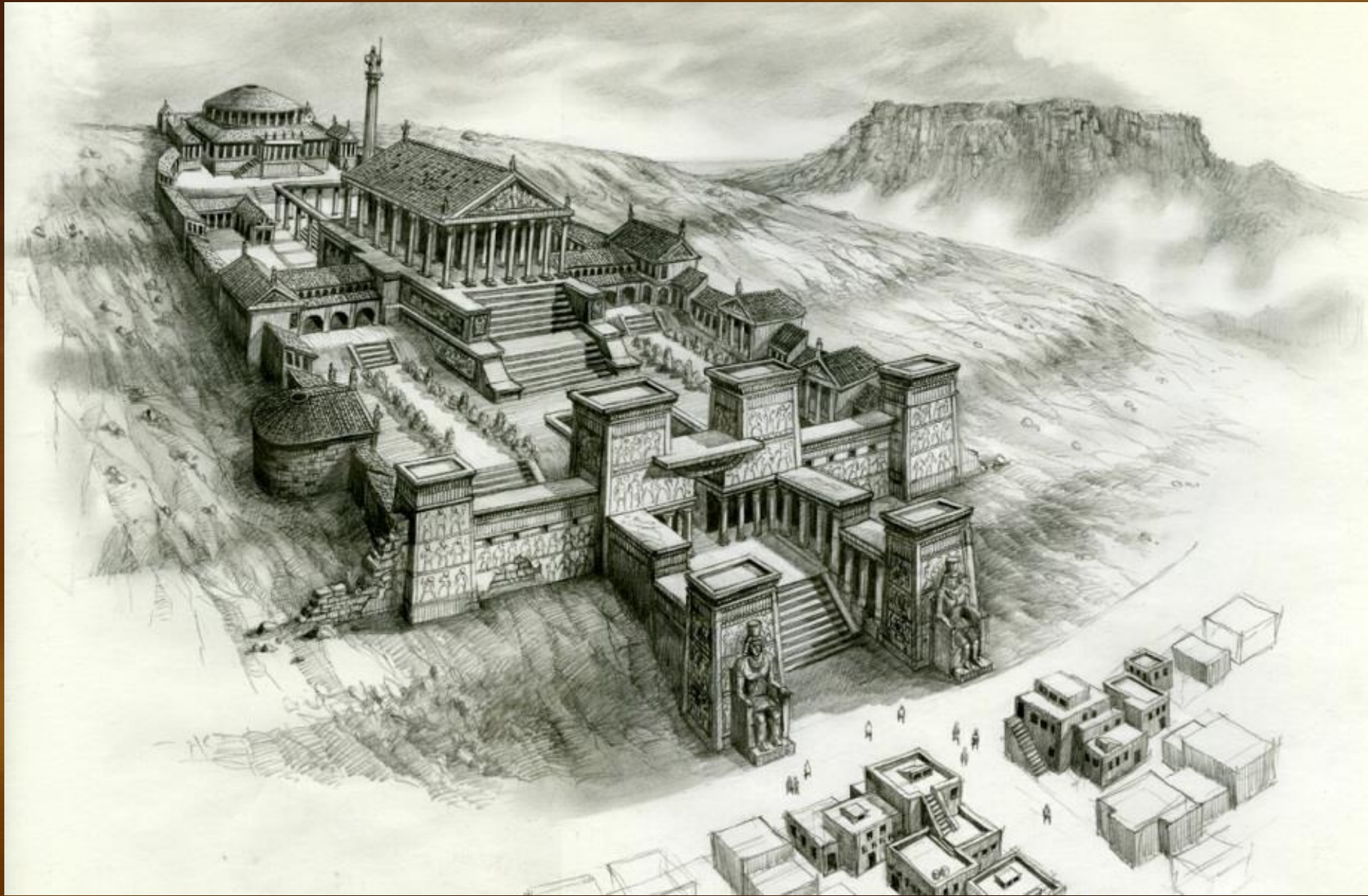



Great Library of Alexandria

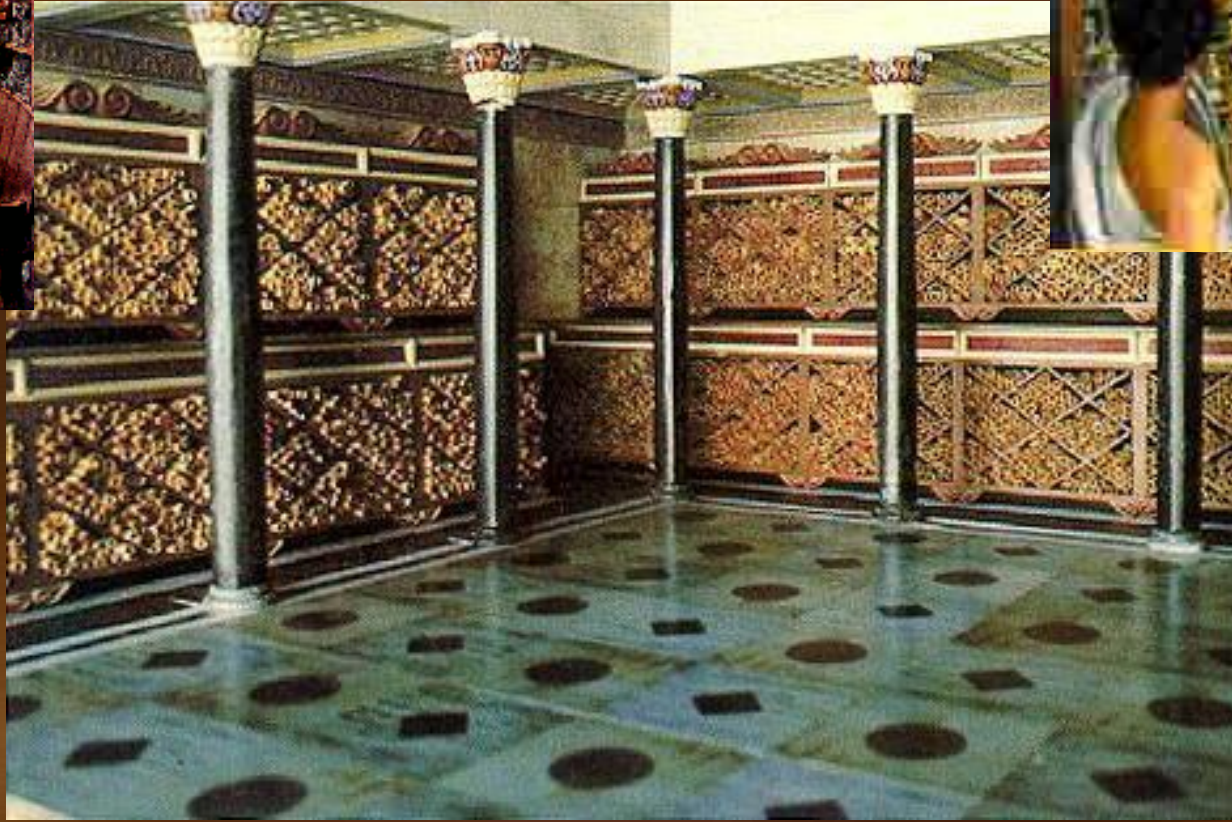
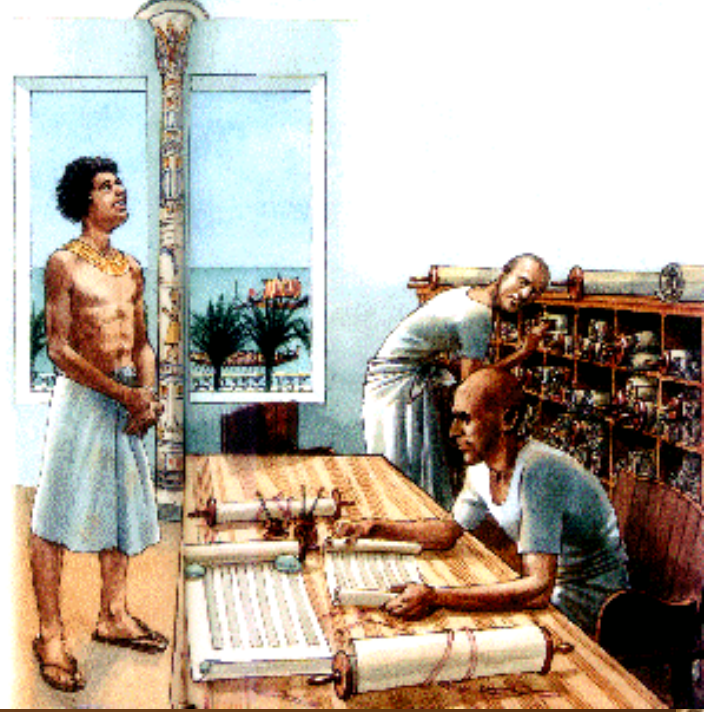

Great Library of Alexandria

Great Library of Alexandria Burned – 48 BC



Mediterranean Sea

Ancient Alexandria, Egypt, Around the Time of Hypatia



$\phi = +31^{\circ}12' N$
 $\lambda = +29^{\circ}15' E$

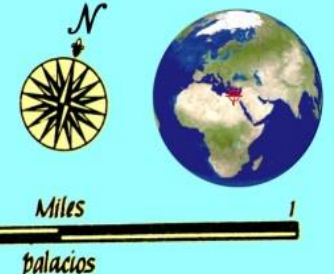



Bibliotheca Alexandria - 2002





Bibliotheca Alexandria - 2002



Hero

10AD – 70 AD

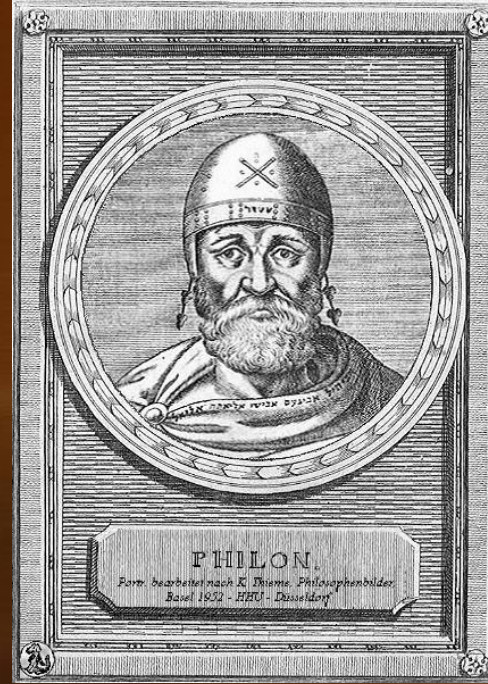

Philo

20 BC – 50 AD

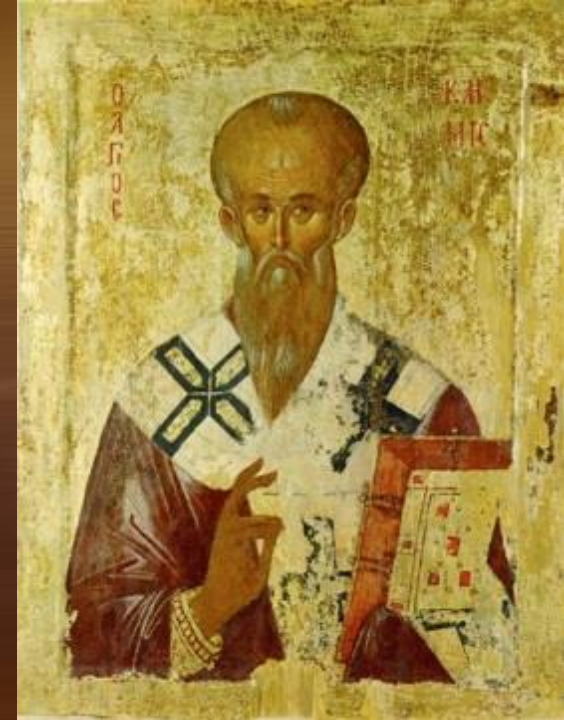

Clement

150 AD – 215 AD

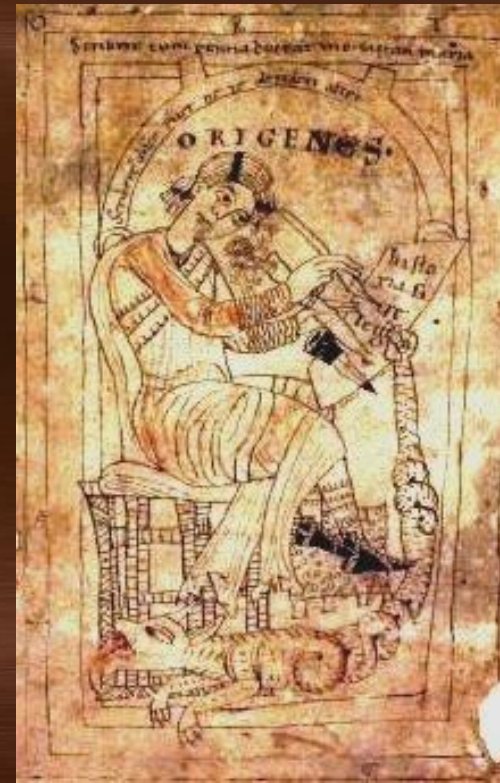

Origen

183 AD – 254 AD

Mediterranean Sea

Ancient Alexandria, Egypt, Around the Time of Hypatia



$\phi = +31^{\circ}12' N$
 $\lambda = +29^{\circ}15' E$



0 Miles 1
palacios

Science of Alexandria

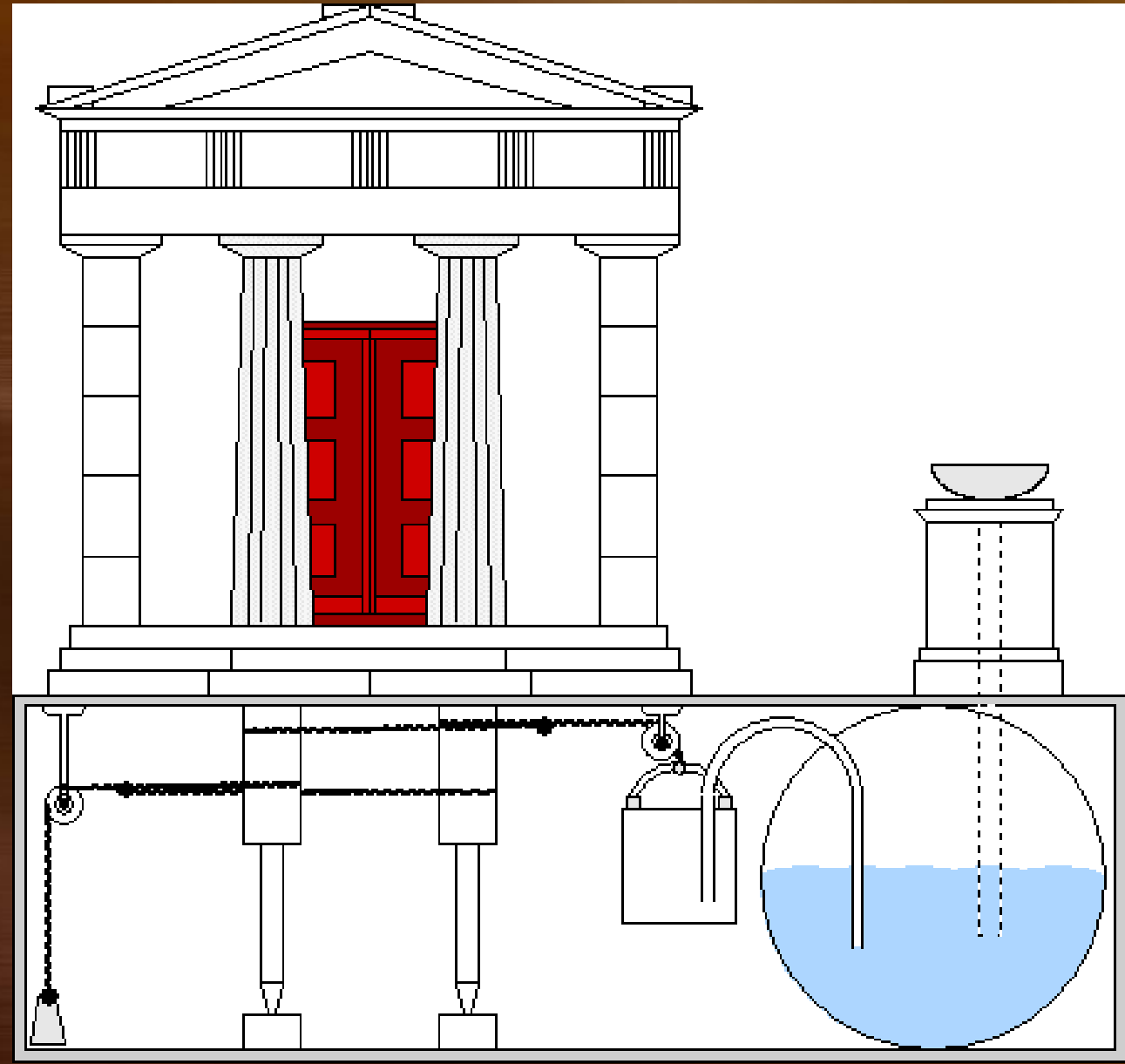
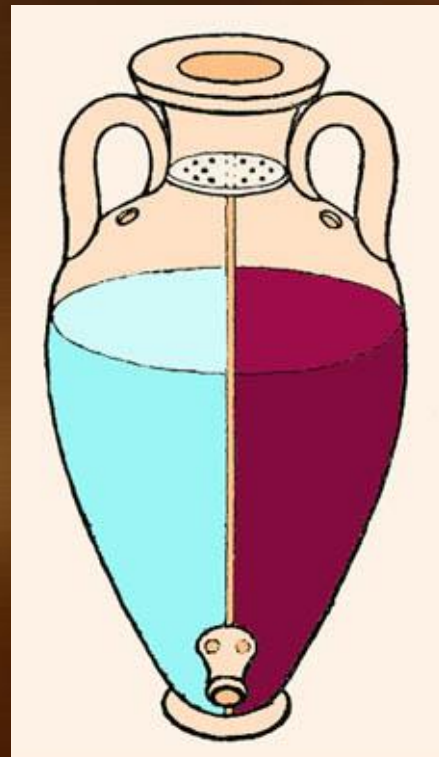
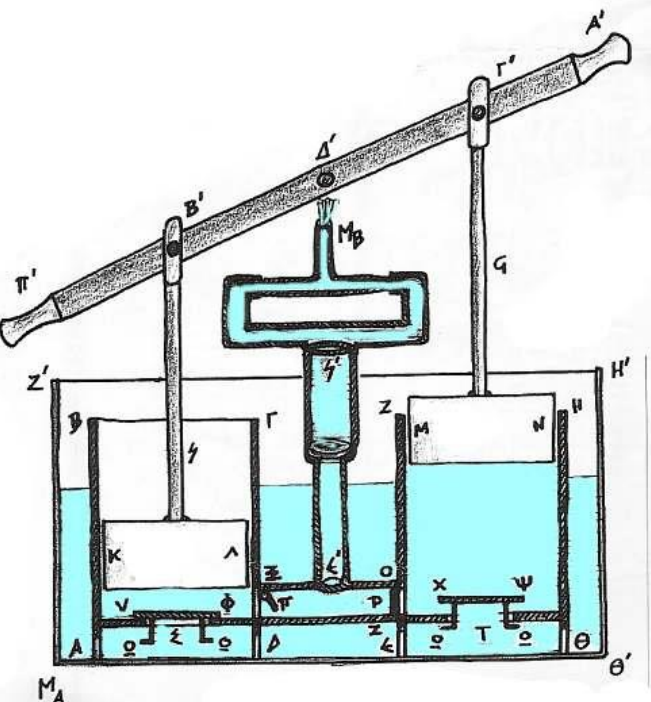

Science of Alexandria

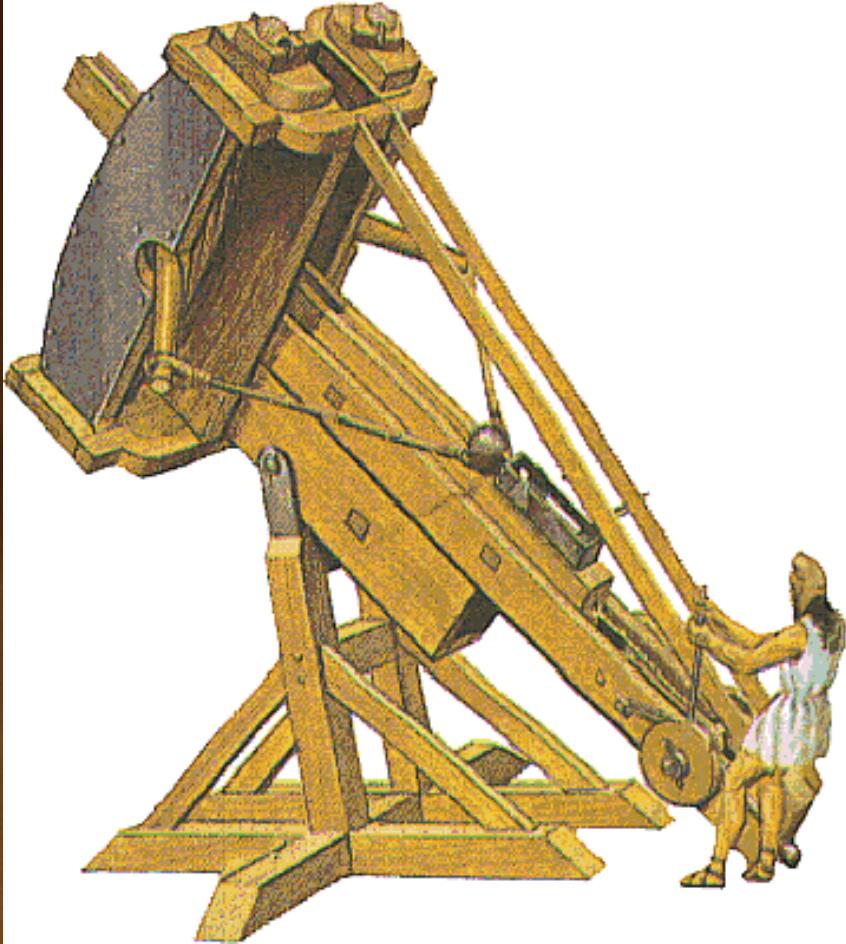



Hero

10AD – 70 AD

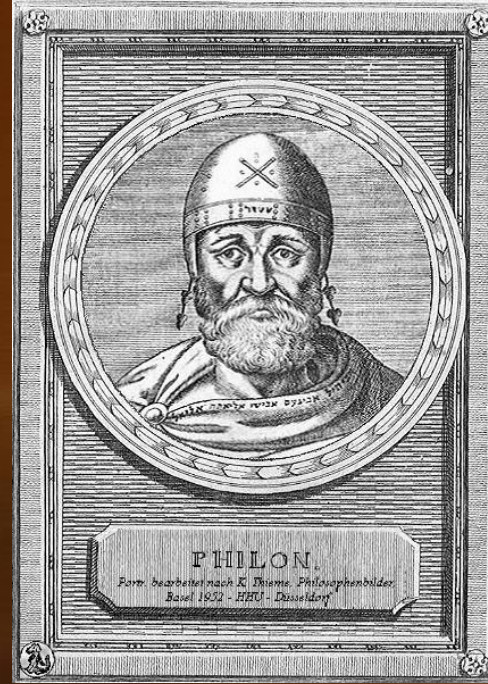

Philo

20 BC – 50 AD

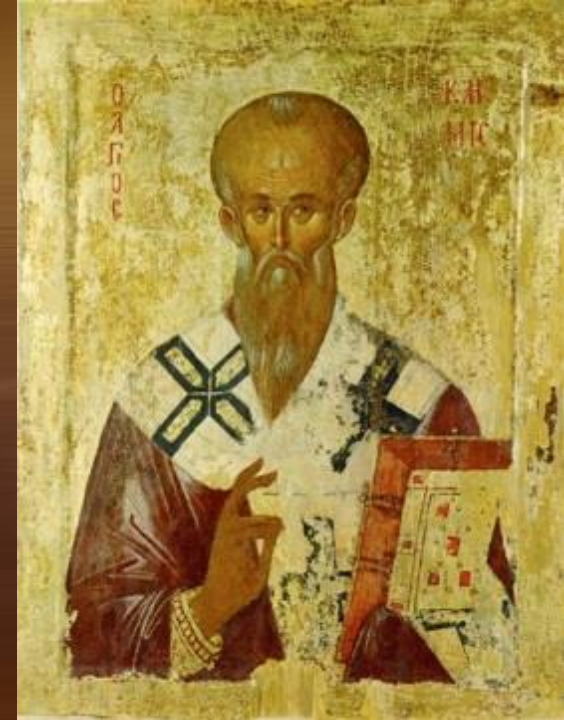

Clement

150 AD – 215 AD

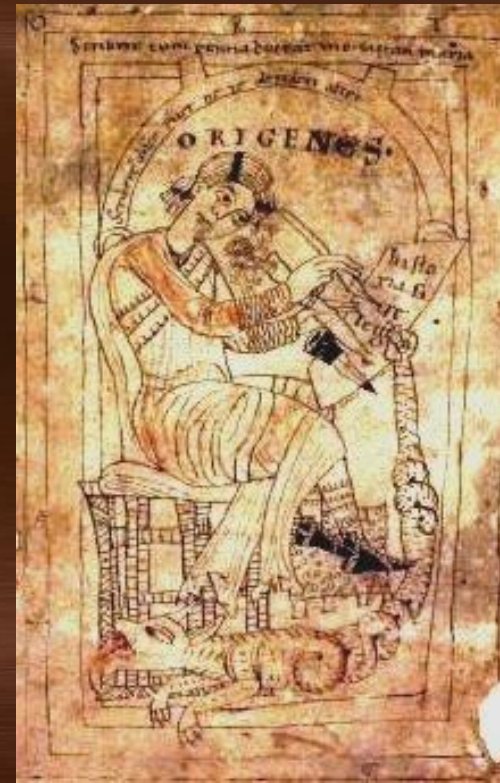

Origen

183 AD – 254 AD

Septuagint

- ~200 BC
- Hebrew and Aramaic to “Koine” (Common) Greek
- Greek Language spoken until 600 AD when Byzantine Greek became the norm.

Septuagint

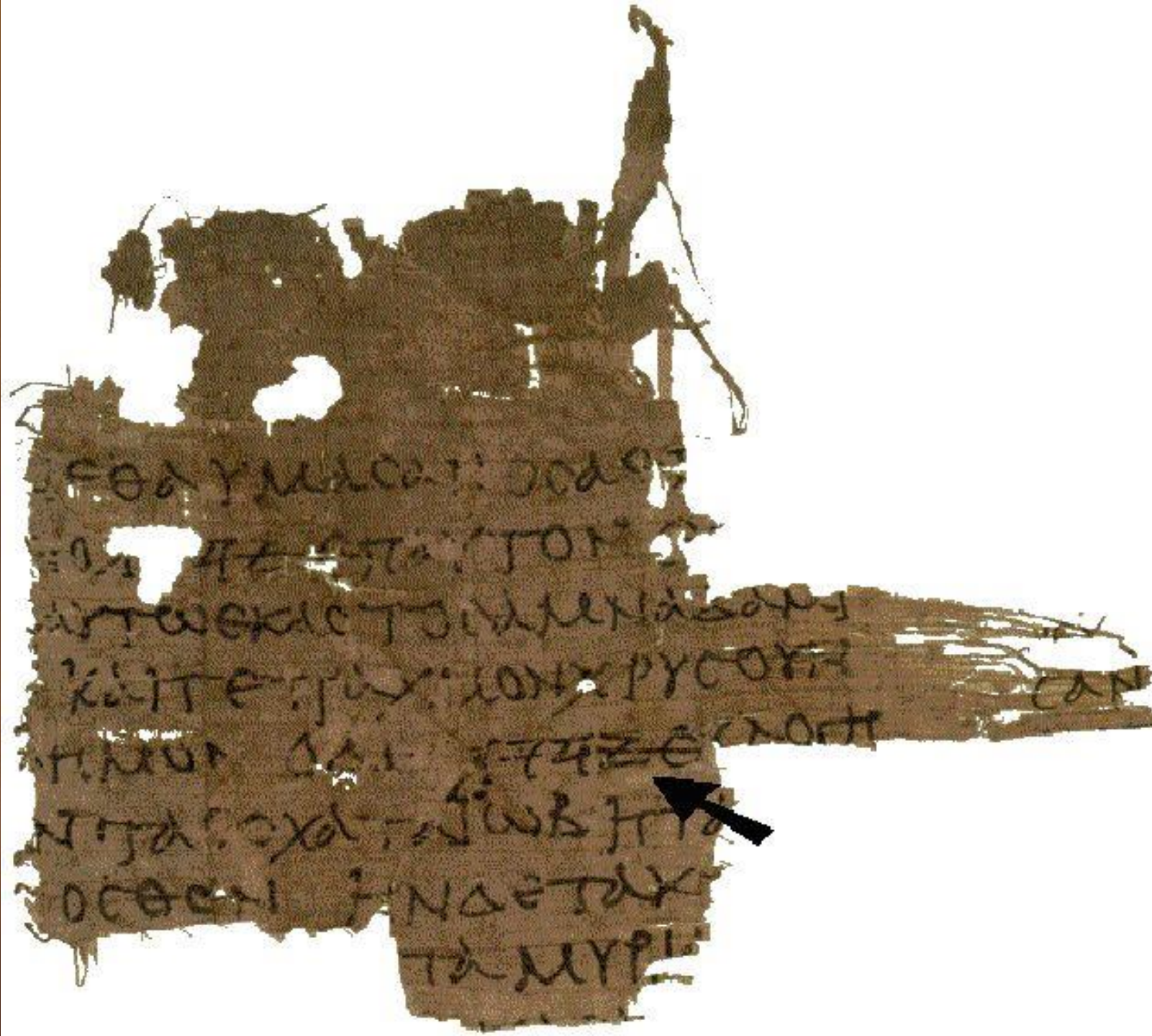

Old Testament Translation History

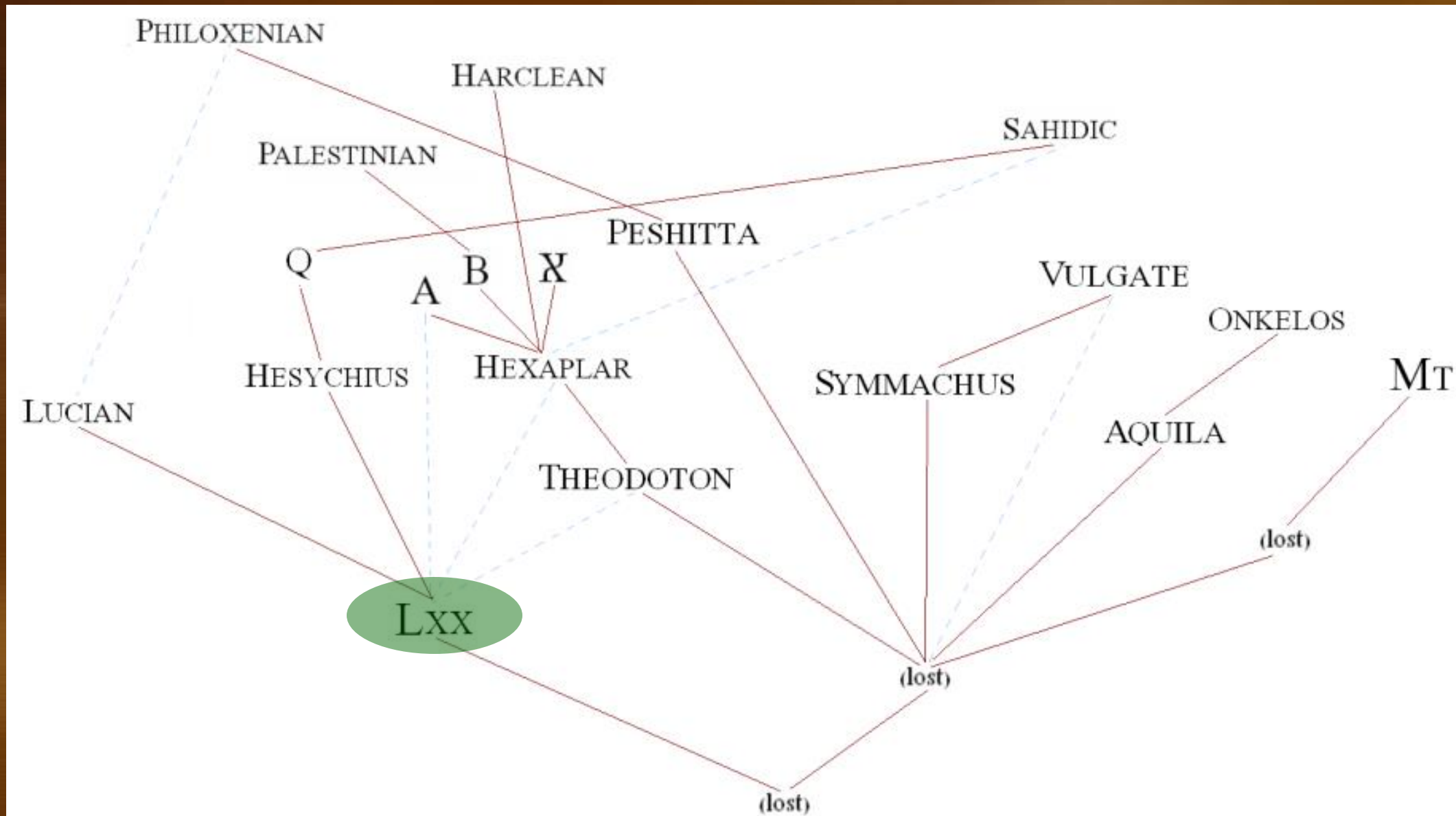



Hero

10AD – 70 AD

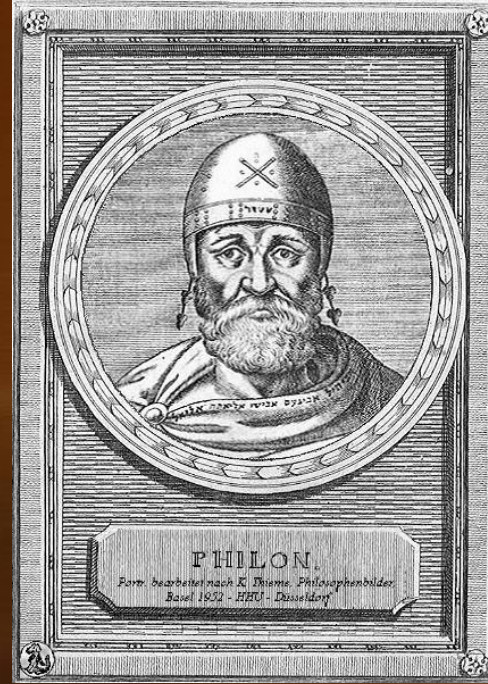

Philo

20 BC – 50 AD

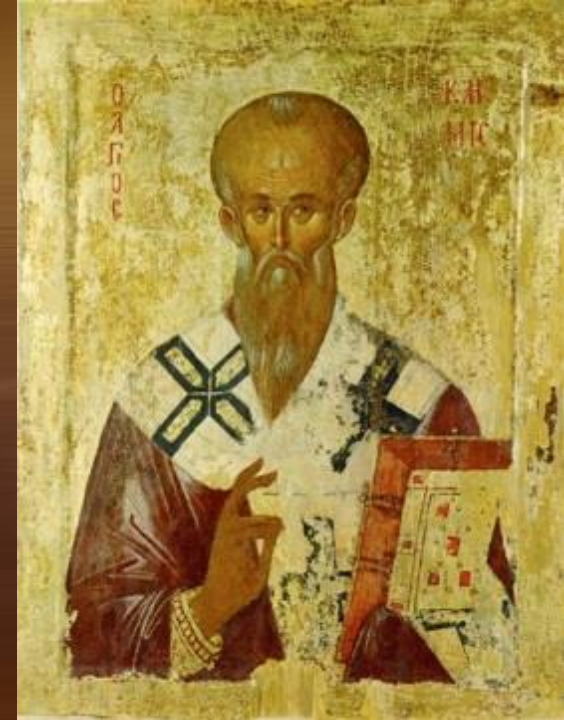

Clement

150 AD – 215 AD

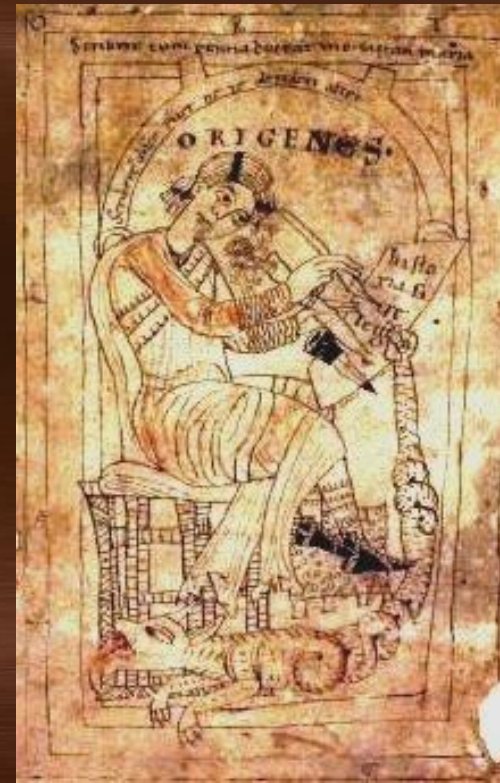

Origen

183 AD – 254 AD

Old Testament Translation History

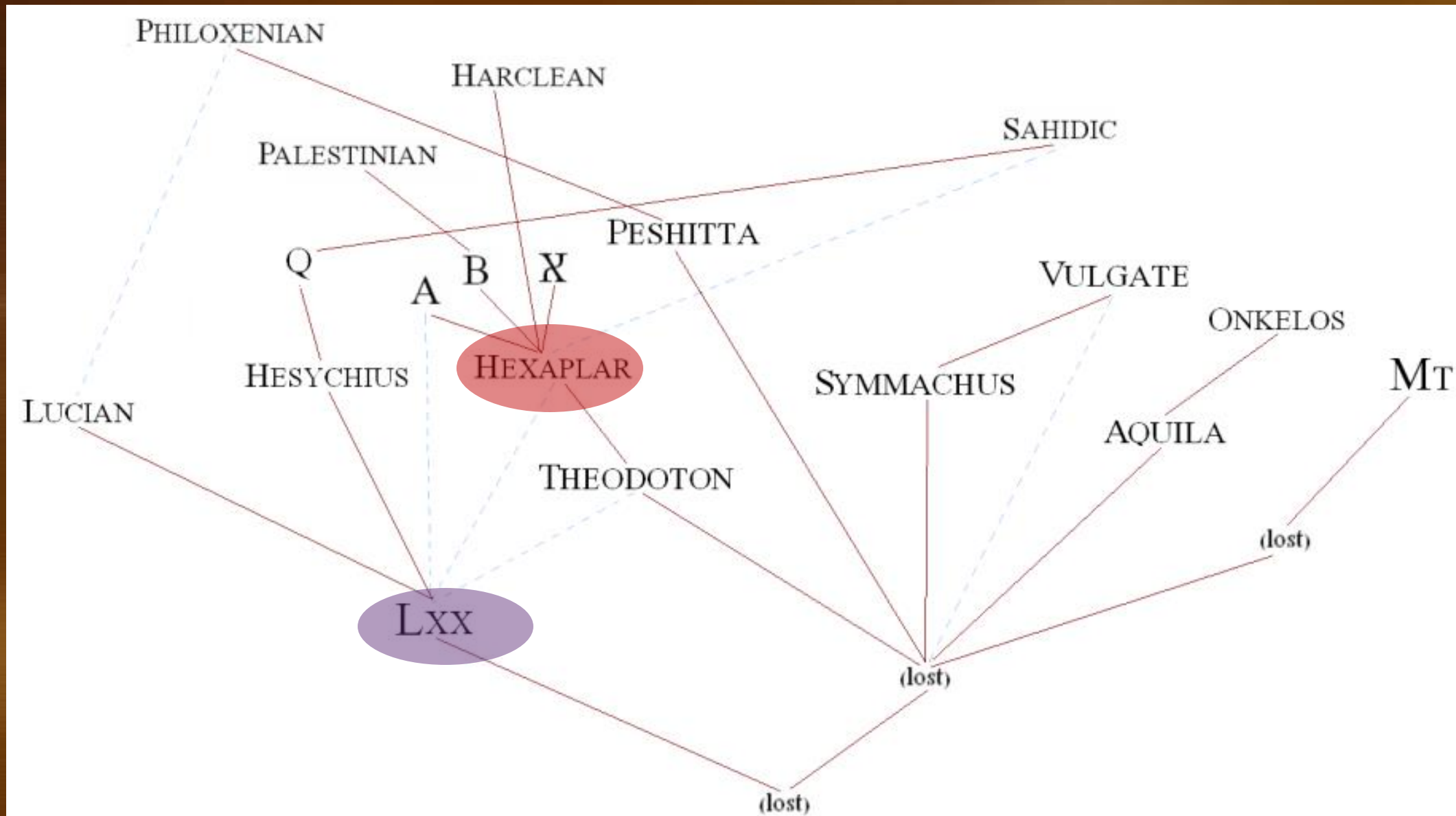

Old Testament Translation History

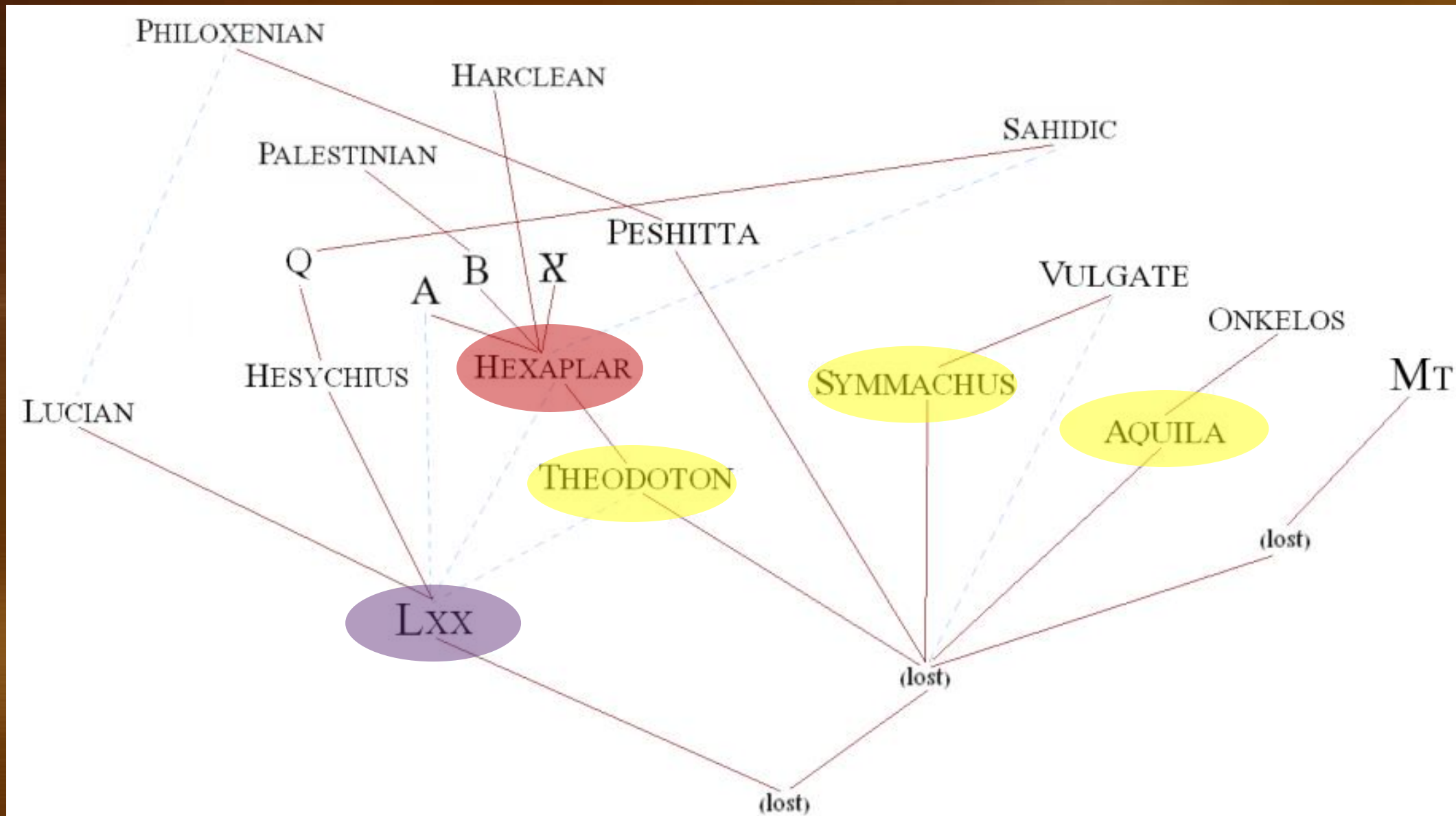

Old Testament Translation History

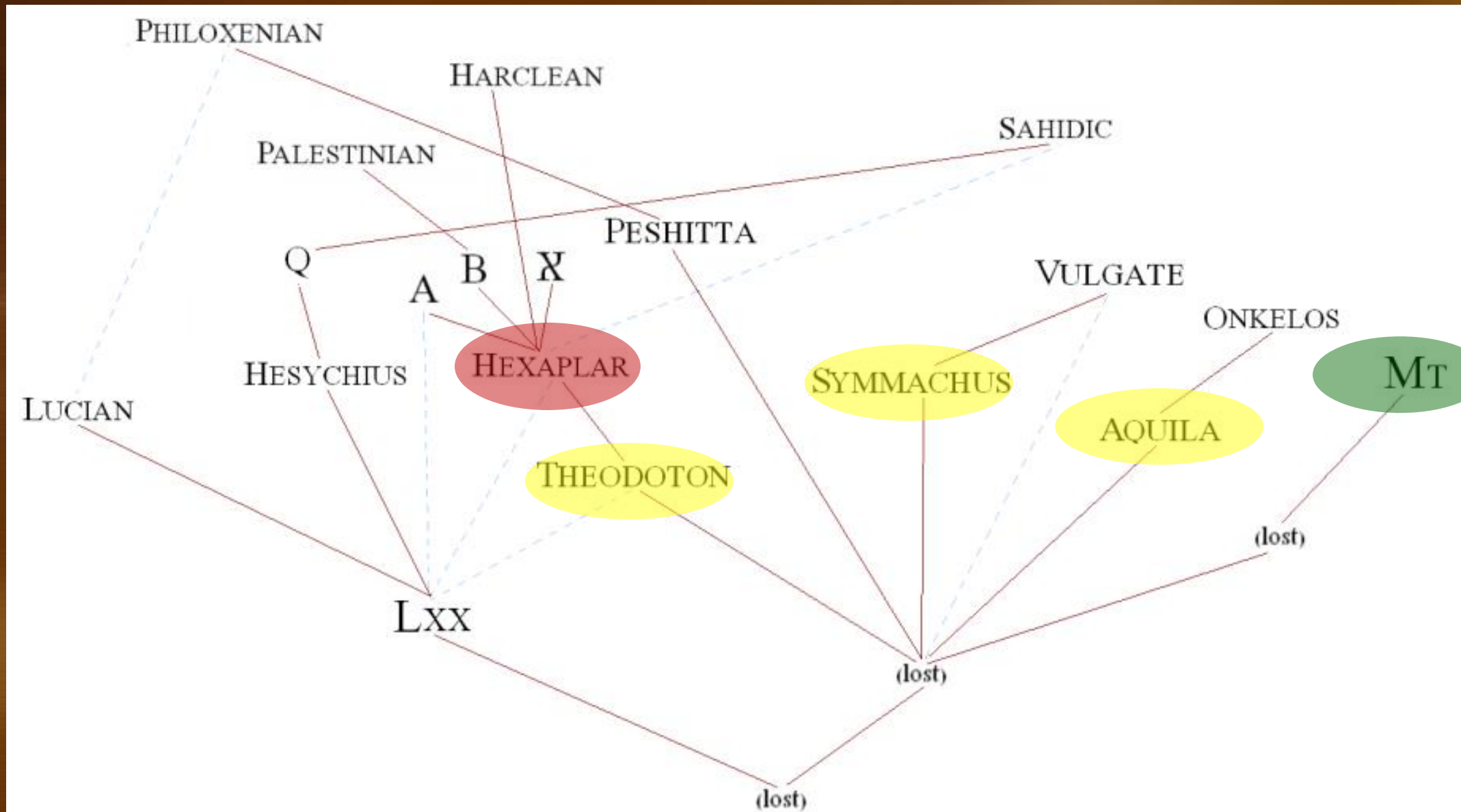



Masoretic Text

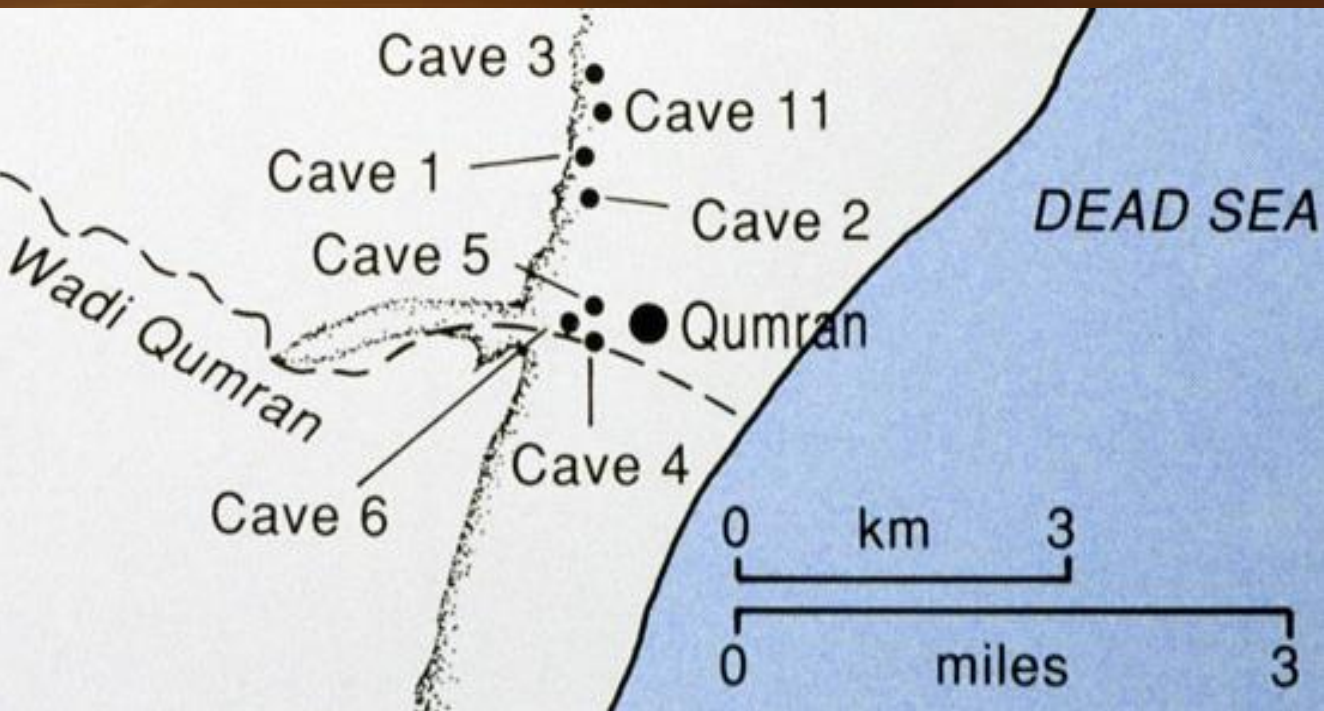



PAUL'S THIRD MISSIONARY JOURNEY





Paul's Most Beloved Church





Soko

A NASA IMAGE

Miletus

Ephesus

Kusadasi

Samos



Kusadasi Harbor





Ephesus Harbor



Acadian Way



Acadian Way



Acadian Way



© Archaeologyillustrated.com

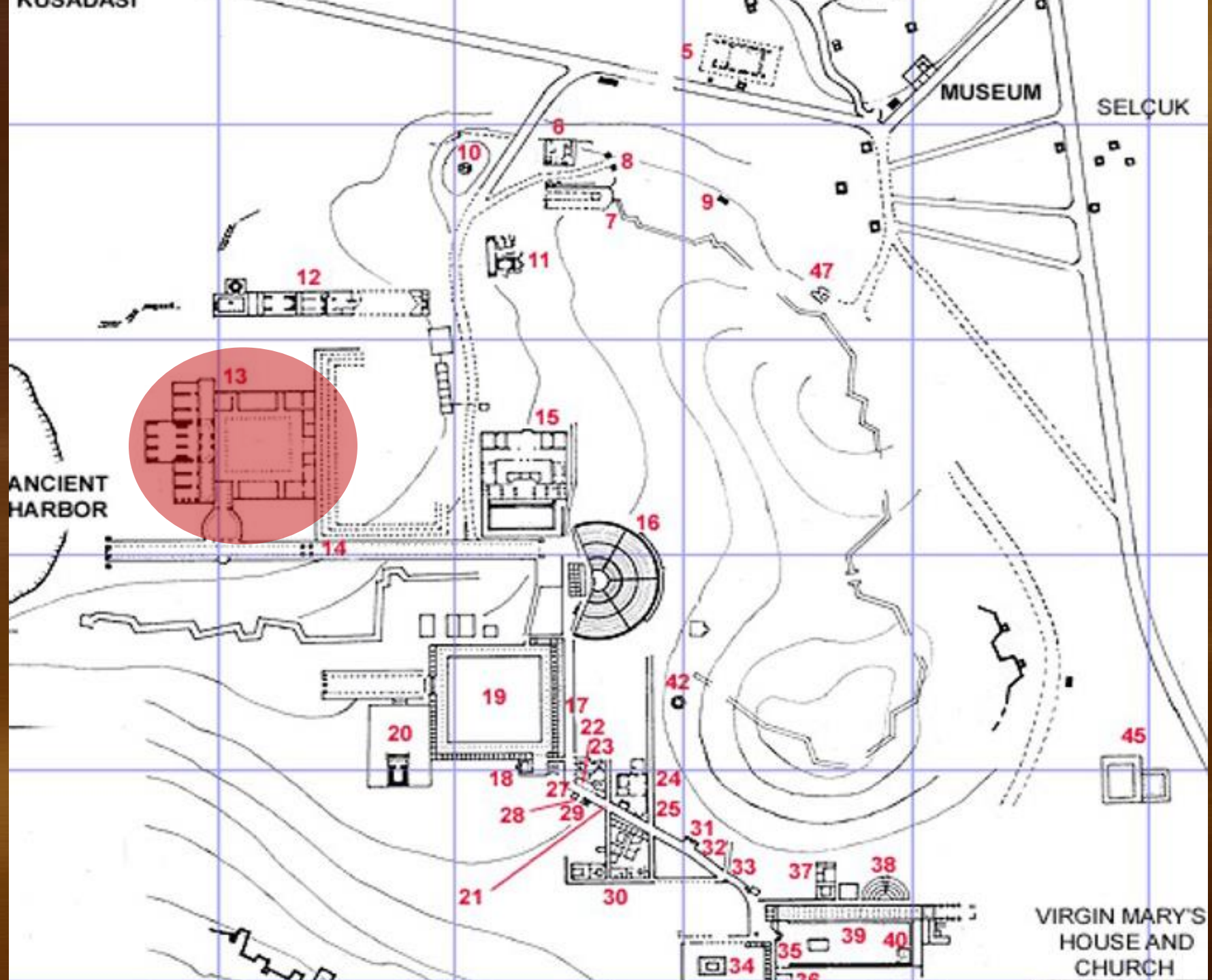

Civic Agora-Forum

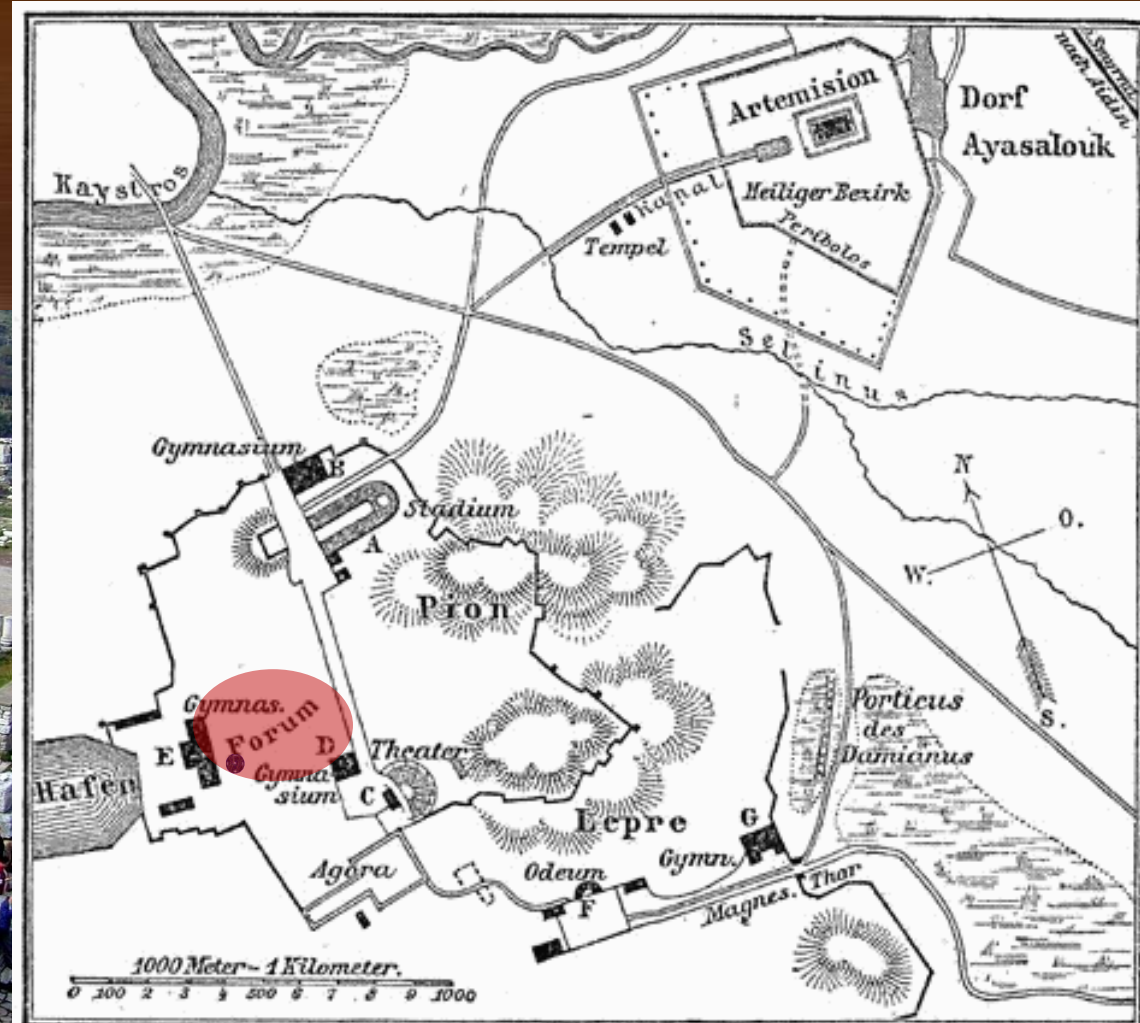

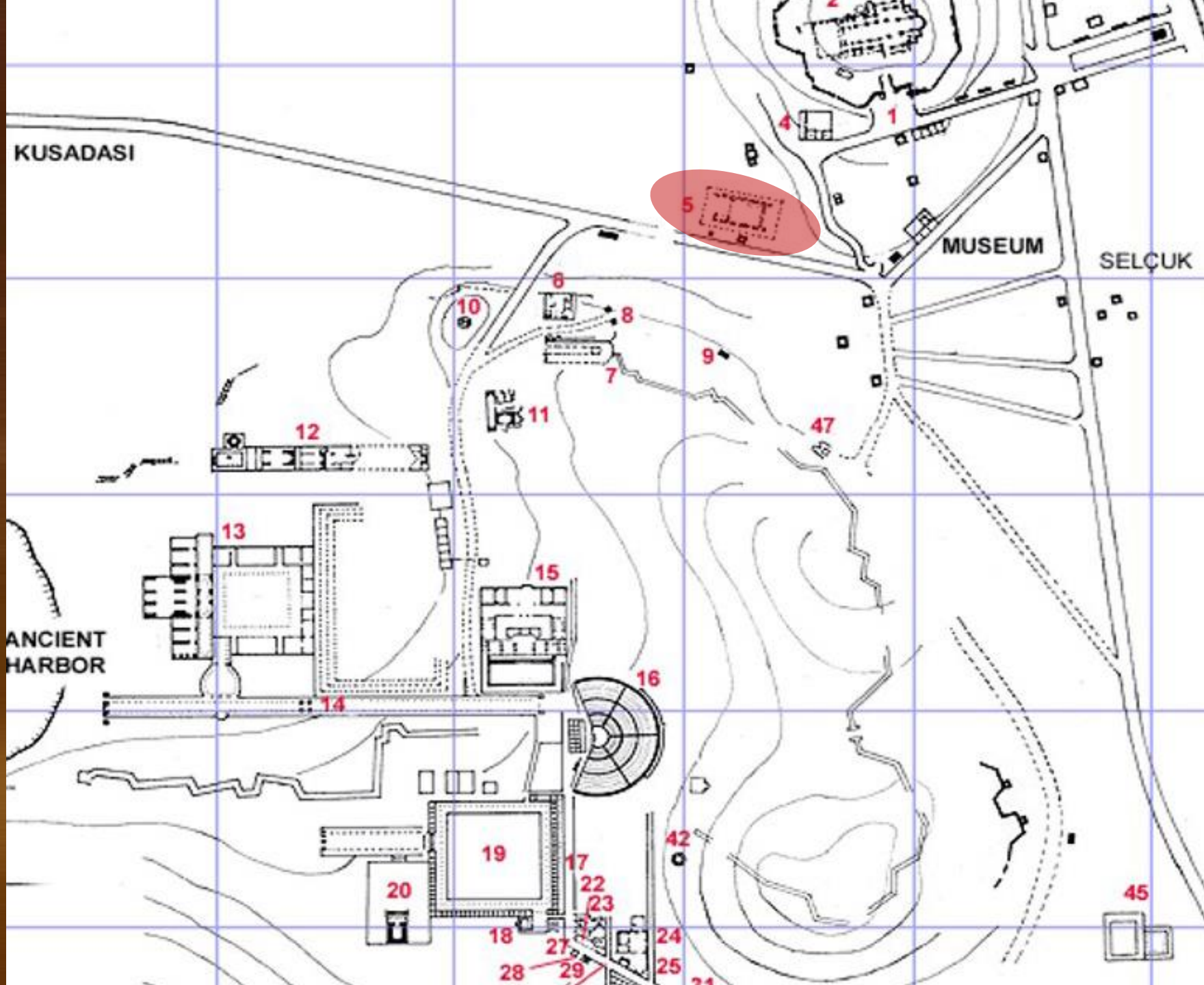

Temple of Diana (Artemision)



Temple of Diana (Artemision)

Constructed ~356 BC

60 feet high

450 feet long

225 feet wide

127 Columns

Deactivated in 407 AD as the
Roman Empire became
Christian



Diana (Roman) Artemis (Greek)



Artemis was the goddess of the hunt, the wilderness, wild animals, nature, vegetation, childbirth, care of children, and chastity.



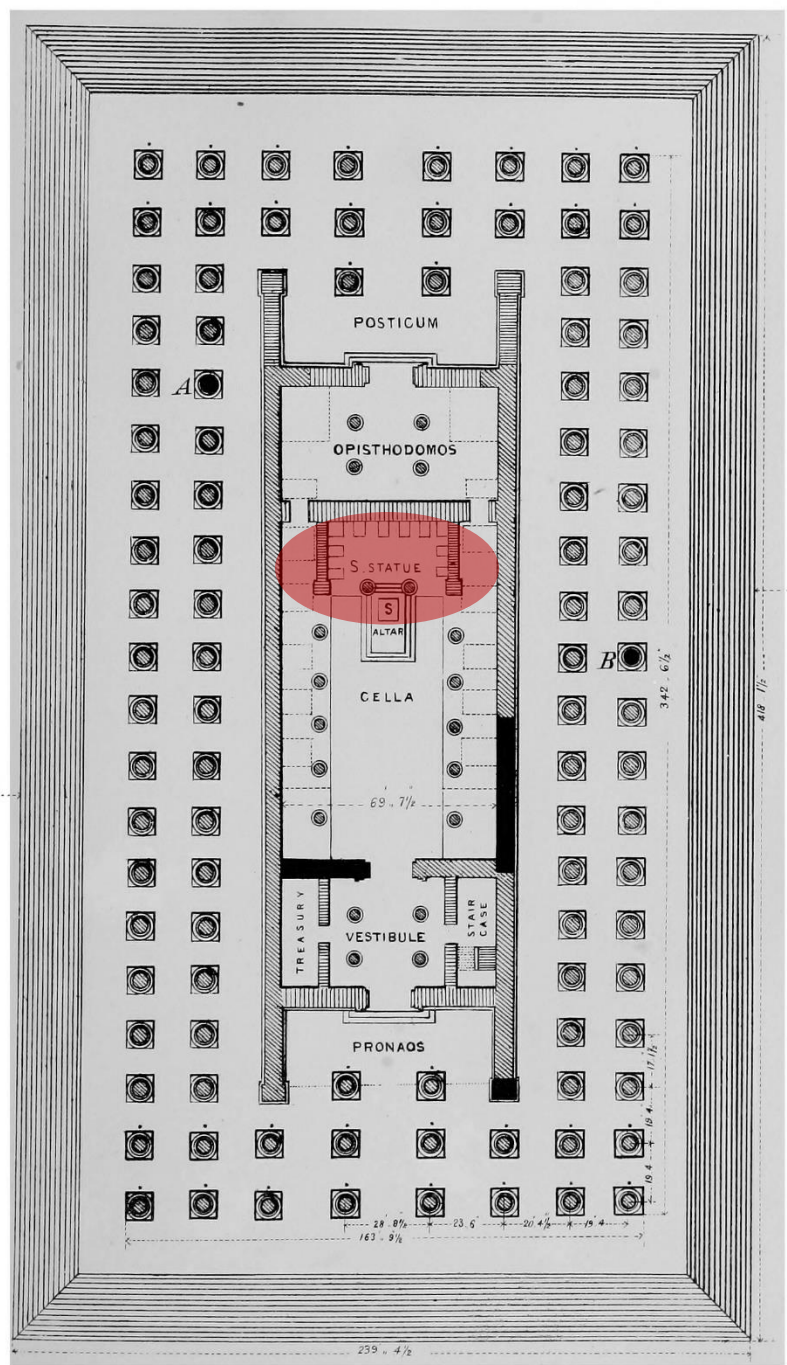

PLAN







EPHESUS

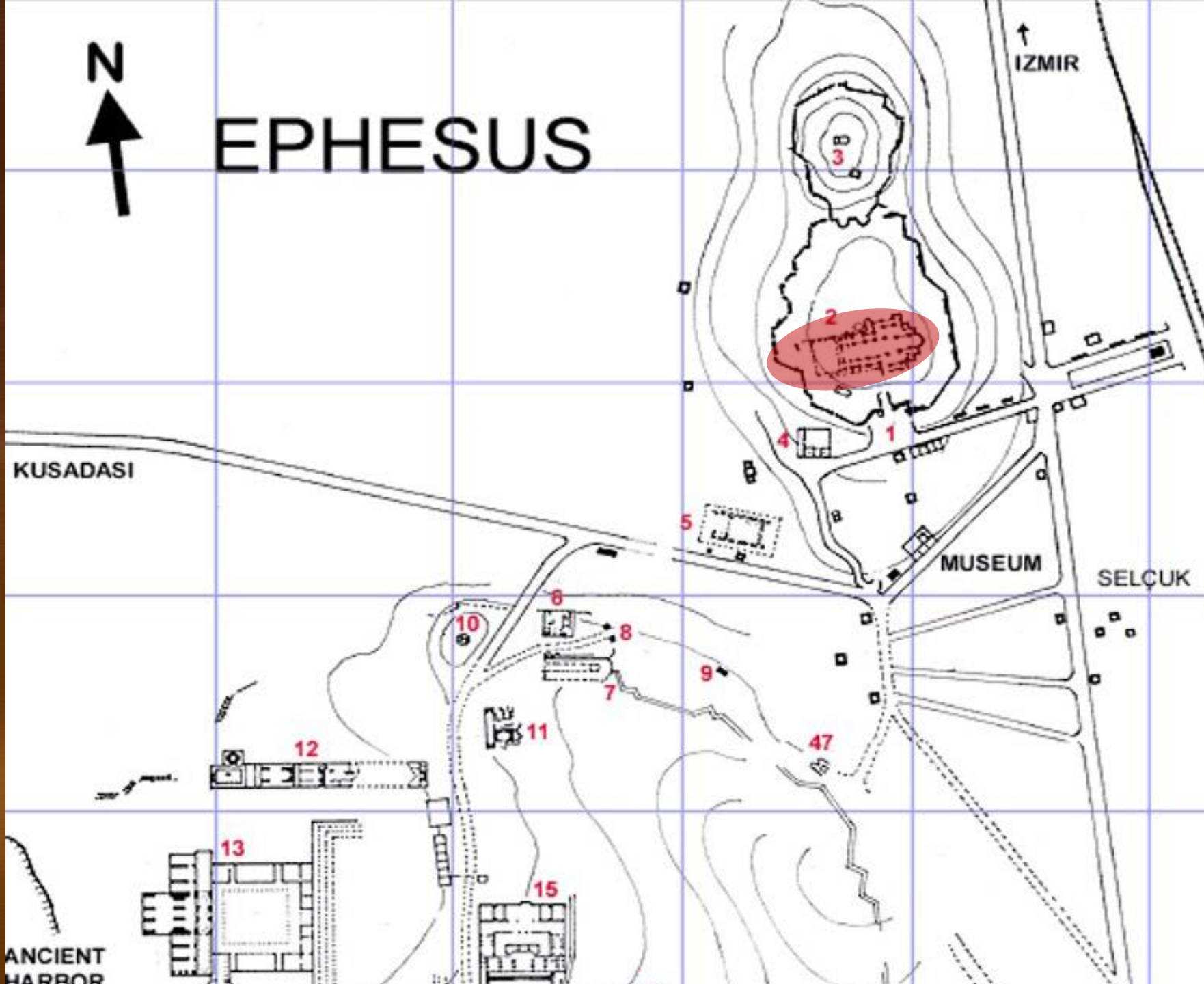

↑
IZMIR

KUSADASI

MUSEUM

SELÇUK

ANCIENT
HARBOR

Basilica of St. John



Justinian (527 to 565 AD)

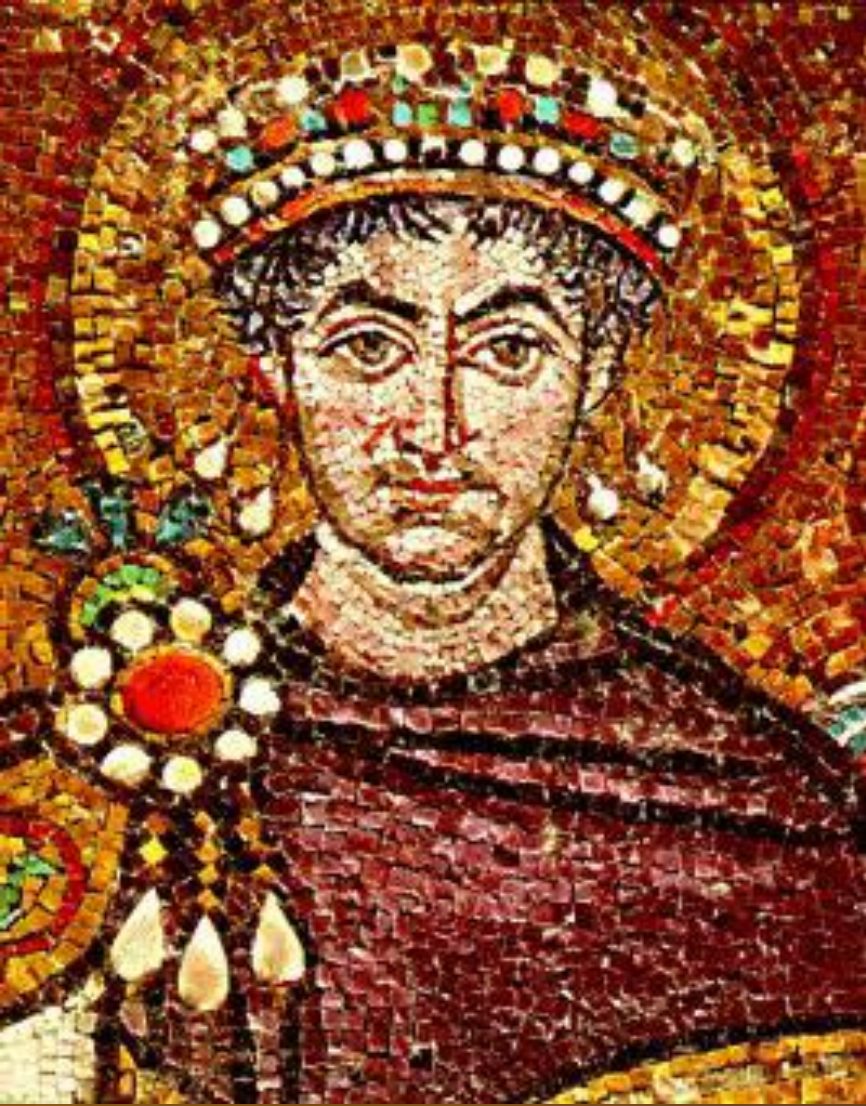







ST. JEAN IN MEZARI
THE TOMB OF
ST. JOHN

ST. JEAN IN MEZARI
THE TOMB OF
ST. JOHN

Next Week:

“Correction and Conflict”